

# W360 Animal Health UVA / UVB Light

## 30W LED / 55°



- Broadband UVA for Animal Health
- UVB for Reptile Vitamin D3 Synthesis
- Adjustable Intensity
- DMX Controllable
- Also Available with Other Optics

### ORDERING GUIDE

**CXW360BD** - UVBA -  -  -  -

#### Spectrum

UVBA UVBA

#### Finish

WH White  
BK Black

#### Mount

TOX w/ O-type DMX Track Adapter  
TON w/ O-type Non-DMX Track Adapter  
CLP w/ Clamp Mount  
MPT w/ Monopoint Adapter Mount (PSX+120V only)

#### Power Supply & Control

PS Power Supply



PSX Power Supply w/ DMX  
(compatible with TOX/MPT mount)



#### Plug/Connection

US US 120V  
EU EU 220V

### SPECIFICATIONS

Beam Angle	55°
Spectrum Type	UVBA
Control	Intensity (0% - 100%)
LED Source	DiCon Dense Matrix LED
Power Draw	AC 30W max
AC Input Voltage	100 - 240V AC, 60Hz
Cooling	Fan Cooled
Operating Temperature	32 - 104°F (0 - 40°C)
Fixture Weight	1.3lb (~0.6kg)
Power Supply Weight	1.0lb (~0.4kg)

MECHANICAL FIGURES

W360BD-TOX/TON

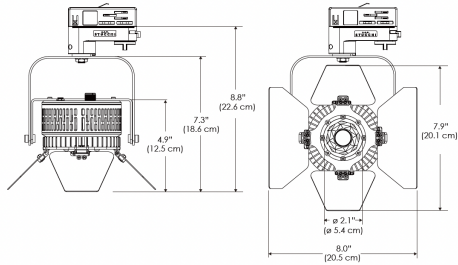

PS US

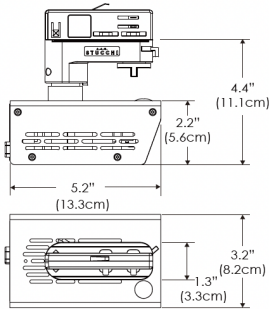

PSX US

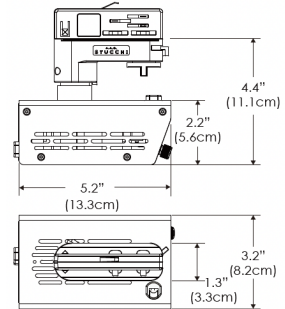

W360BD-TOX/TON

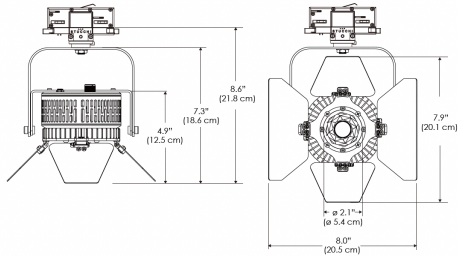

PS EU

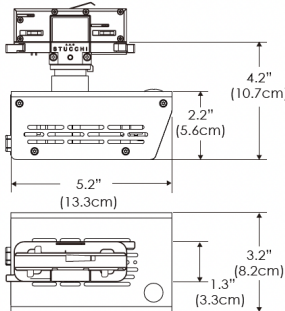

PSX EU

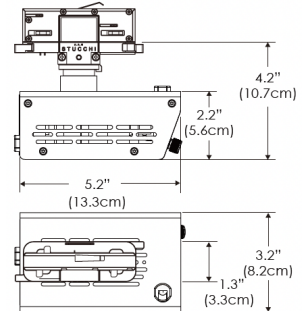

W360BD-CLP

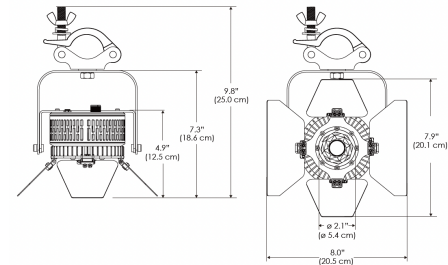

PS US EU

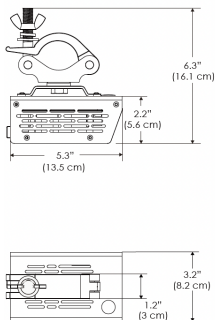

Mounting Bracket Dimensions ALL-CLP

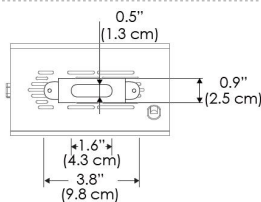

\*All -CLP configuration models come with standard DC cables of 6 inches and AC cables of 10 ft.

W360BD-MPT

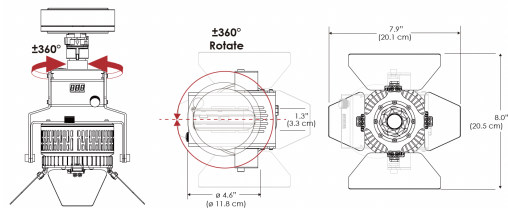

PSX US

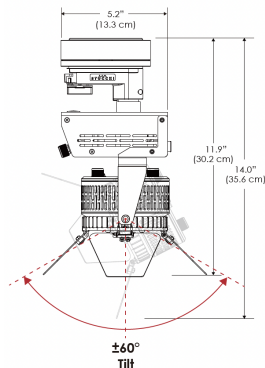

PSX EU

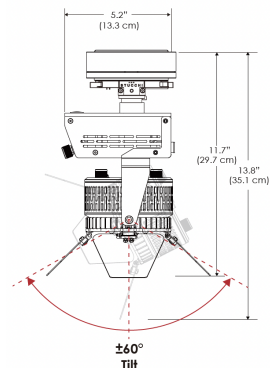

PHOTOMETRIC DATA

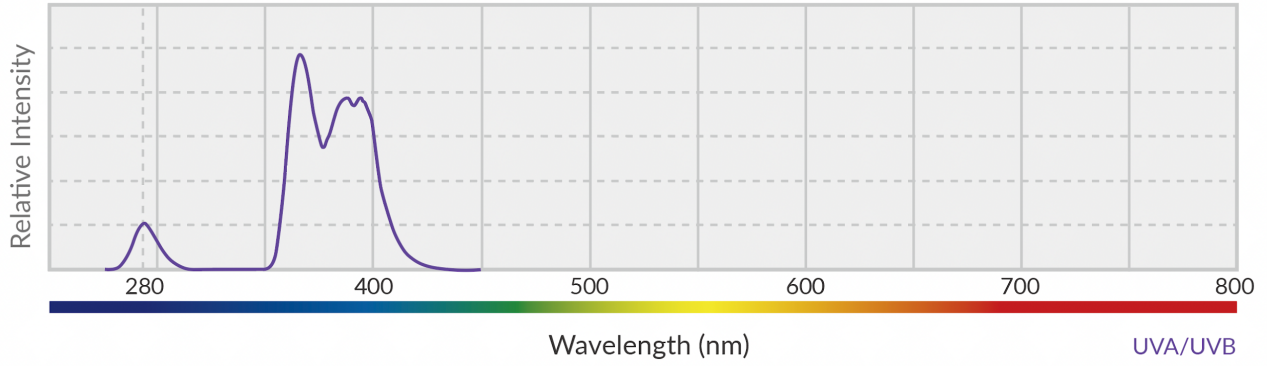

Distance	1' (~0.3 m)	3' (~0.9 m)	5' (~1.5 m)
Total UV	3302	338	116
UVA	2980	314	108
UVB	322	24	7
Beam Diameter	Ø 2.3' (0.7m)	Ø 7.1' (2.2m)	Ø 11.6' (3.5m)

55°